

SH STH SPH SPPH SPPPH

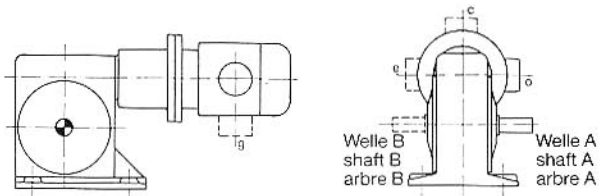

B3

SV
STV
SPV
SPPV
SPPPV

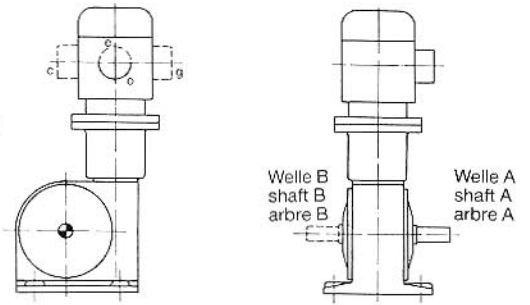

B3

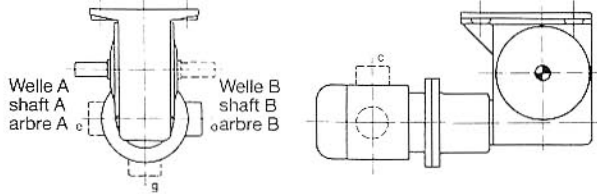

B8

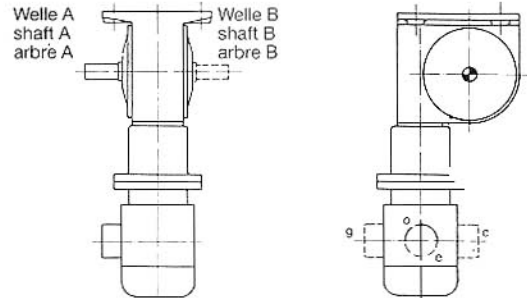

B8

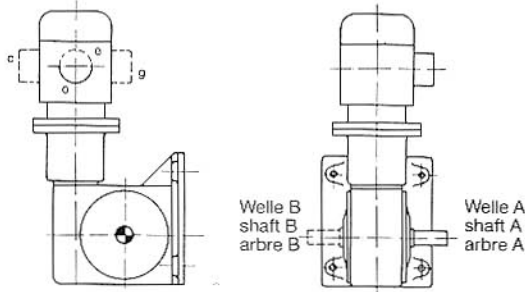

B6

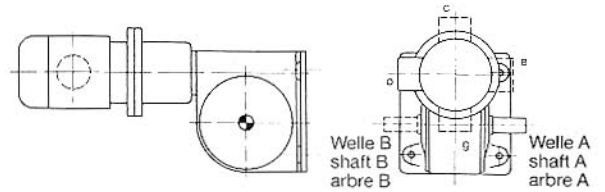

B6

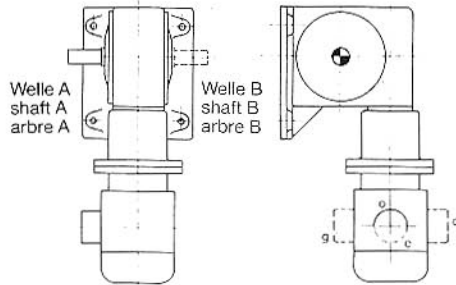

B7

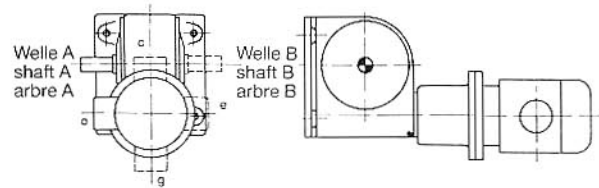

B7

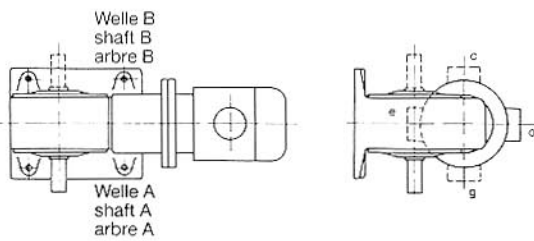

V5

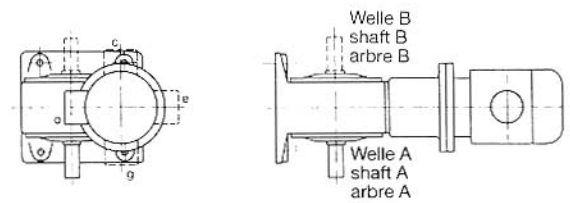

V5

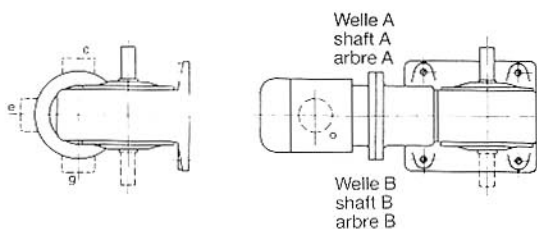

V6

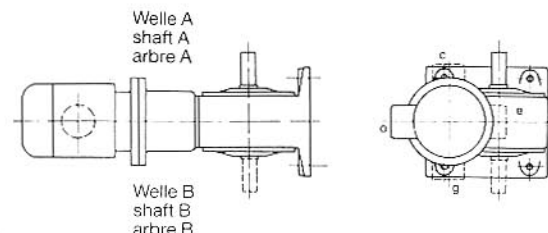

V6

Bei Bestellung Klemmkastenstellung (o, g, e, c) angeben.
Quote terminal box position (o, g, e, c) with order.
Veuillez indiquer la position de la boîte à bornes (o, g, e, c) lors de la commande.